

# Valve for Water and Chemical Base Fluids

## VCC Series

### 2/3 Port Air Operated Valve

#### Applicable for 2 liquid paint (VCC12D)

- PTFE diaphragm structure = Sliding part eliminated
- Less paint adhesion

#### Mountable on a robot arm (space-saving, lightweight)

- 2 valves per station (30 mm pitch)
- 2/3 port valves mixed mounting
- Resin manifold block



SUS316L Stainless steel fitting

**VCK Series /  $\varnothing 6$  to  $\varnothing 12$**



2 port valve

**VCC12(D)**



3 port valve

**VCC13**



VNA

VNB

SGC

SGH

VNC

VNH

VND

**VCC**

TQ



# Manifold Valve

## Separable Resin Manifold Block

- Easy addition and reduction of stations
- Tough PPS (Polyphenylene Sulfide) resin is used.
- Fluoresresin is contained. (Less fluid adhesion)
- Antistatic (Surface resistance  $10^2$  to  $10^5 \Omega$ )
- SUS316L Stainless steel fitting is standardized.

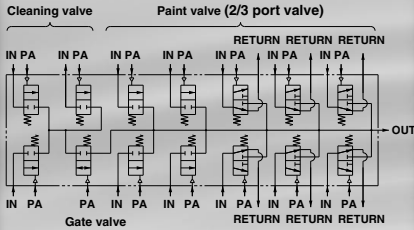
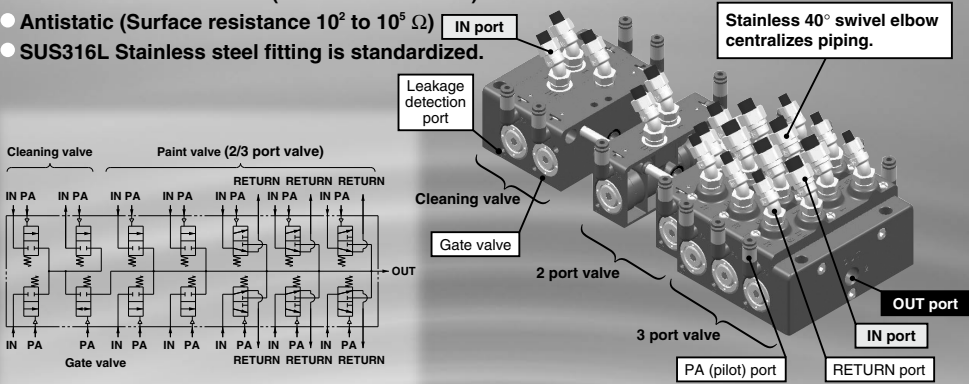

### 2 port valve manifold block assembly

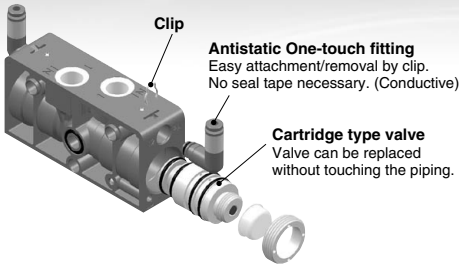

### 3 port valve manifold block assembly

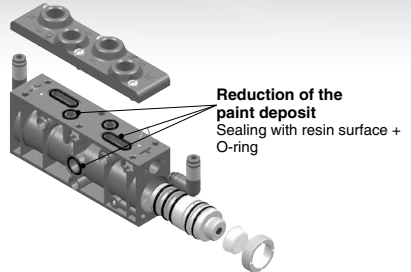

Less build-up of liquid → Better cleaning performance, reduce mixing of colors  
Liquid build-up at valve is 0.01 cc or less.  
Ensures stable sealing performance for misalignment.

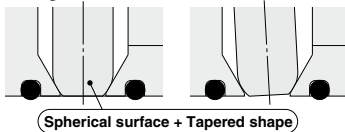

Special fluororesin seal

O-ring back-up ensures sealing performance.

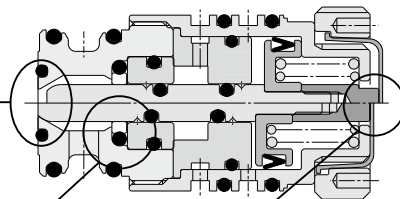

Indicator function

Operating condition can be checked visually, or by touching.

Indicator color  
Blue ... VCC12, 13  
Red ... VCC12D

Standard (Sliding type)

Diaphragm type

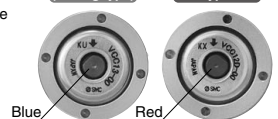

VNA
VNB
SGC
SGH
VNC
VNH
VND
VCC
TQ

## Single Unit

### ● 2 port valve

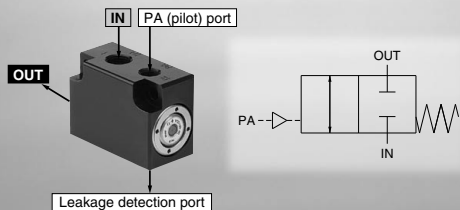

### ● 3 port valve

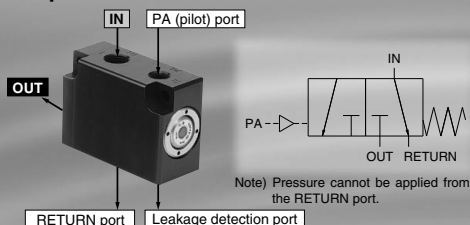

## SUS316L Stainless Steel Fitting

VCKH



Male connector

VCKK



40° swivel elbow

VCKL



90° swivel elbow

- 40° swivel elbow is added in line-up.
- Seal tape is unnecessary. No chance of insulation. (Applicable for paint with high voltage)
- Attachment/removal in a narrow space is easy.

Type	Model	Port size	Applicable tubing O.D. x I.D.
Male connector	VCKH	G1/4	6 x 4
40° swivel elbow	VCKK		8 x 6
90° swivel elbow	VCKL		10 x 8 10 x 7.5 12 x 9

## Special Tools

**Disassembly and maintenance are possible.**

Product design takes maintenance performance into consideration.

### Attaching/Detaching valve

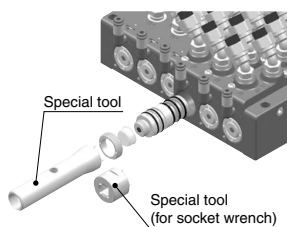

### Disassembling/Cleaning valve element

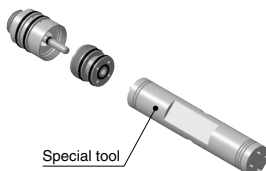

### Attaching/Detaching tubing

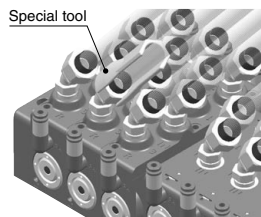

## Made to Order

Check valve (Part no.: AK-DPO 00057) Regulator (Part no.: XT13-406-X200)

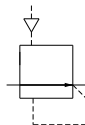
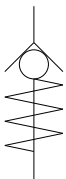

Note) Applicable to special manifold, too.

---

# Valve for Water and Chemical Base Fluids

## (2/3 Port Air Operated Valve)

---

# VCC Series

## I N D E X

● <b>How to Order</b>	<b>P.646</b>
-----	
● <b>Specifications/Weight</b>	<b>P.648</b>
-----	
● <b>Dimensions</b> Single valve unit	<b>P.650</b>
-----	
Manifold	<b>P.651</b>
-----	
SUS316L Stainless steel fittings	<b>P.652</b>
-----	
● <b>Special Tools</b>	<b>P.654</b>
-----	
● <b>Disassembly/Assembly/ Maintenance Procedure</b>	<b>P.656</b>
-----	
● <b>Replacement Parts</b>	<b>P.658</b>
-----	
● <b>Specific Product Precautions</b>	<b>P.662</b>

VNA
VNB
SGC
SGH
VNC
VNH
VND
<b>VCC</b>
TQ

# Valve for Water and Chemical Base Fluids (2/3 Port Air Operated Valve)

# VCC Series

Please refer to "Manifold Specification Sheet" in the back of page 667.

## How to Order

### Valve

VCC12-00

#### Passage number

2	2 port valve
3	3 port valve <small>Note 2)</small>
2D	2 port/Diaphragm type (Applicable for 2 liquid paint)

Note 1) Valves must be mounted in the right direction. Refer to page 657.

Note 2) Pressure cannot be applied from a 3 port valve RETURN port.

#### Port size

00	For manifold mounting
02	Rc1/4 (for single unit) <small>Note)</small>
02F	G1/4 (for single unit) <small>Note)</small>

Note) Part number for sub-base  
For 2 port: VCC12-S-02 Rc1/4)  
02F G1/4)  
For 3 port: VCC13-S-02 Rc1/4)  
02F G1/4)



VCC12(D)-00



VCC13-00

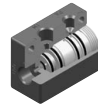

VCC12(D)-02(F)

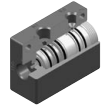

VCC13-02(F)

### Manifold

#### Standard

VV M CC1-06 06 C4

#### Type (Passage number)

2	2 port valve, Cleaning valve
3	3 port valve
M	2/3 port valves mixed mounting

#### Pilot port fitting size

C4	ø4 One-touch fitting (Antistatic)
C6	ø6 One-touch fitting (Antistatic)

#### 2 port valve mountable number

00	No 2 port valves used
02	2 pcs. (colors)
04	4 pcs. (colors)
⋮	⋮

#### 3 port valve mountable number

00	No 3 port valves used
02	2 pcs. (colors)
04	4 pcs. (colors)
⋮	⋮

Note) Maximum mountable valve number: 40 pcs. (in total of 2 port and 3 port valves)

### Circuit example

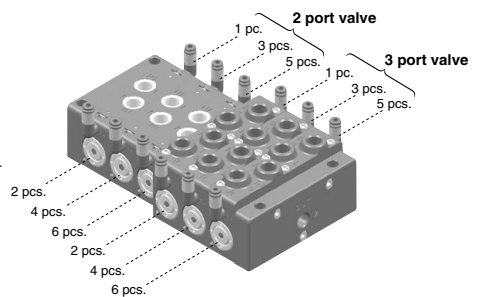
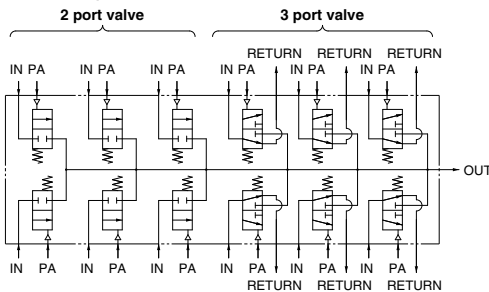

Refer to page 658 for replacement parts.

**How to Order**

**Manifold**

With gate valve **VV M CC1-02 06 C4-G 04**

**Passage number**

2	2 port valve, Cleaning valve
M	2/3 port valves mixed mounting

**2 port valve mountable number**

00	No 2 port valves used
02	2 pcs. (colors)
04	4 pcs. (colors)
⋮	⋮

**3 port valve mountable number**

00	No 3 port valves used
02	2 pcs. (colors)
04	4 pcs. (colors)
⋮	⋮

Note) Maximum mountable valve number: 40 pcs. (in total of 2 port, 3 port and gate valves)

- Gate valve and cleaning valve mountable number**
  - 02 Cleaning valve (2 port valve): 1 pc. + Gate valve: 1 pc.
  - 04 Cleaning valve (2 port valve): 3 pcs. + Gate valve: 1 pc.
  - 06 Cleaning valve (2 port valve): 5 pcs. + Gate valve: 1 pc.
- Pilot port fitting size**
  - C4 ø4 One-touch fitting (Antistatic)
  - C6 ø6 One-touch fitting (Antistatic)

\* Valve for installation is not included in the manifold model.  
 \* Gate valve and cleaning valve (2 port valve) for installation are not included. They are ordered separately. (Gate valve is equivalent to 2 port valve.)  
 \* When cleaning valve number is an even number, use the blanking plug for 2 port valve.

**Circuit example**

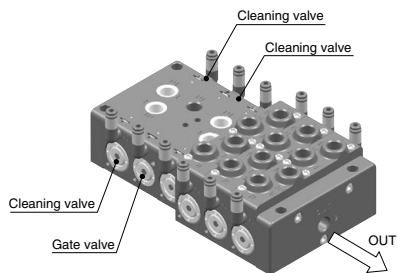
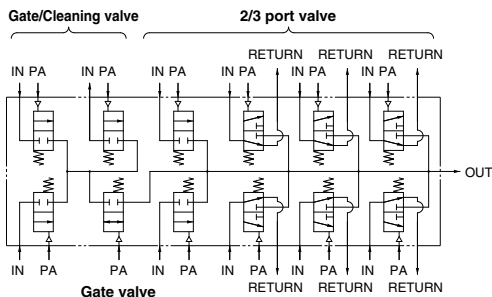

**SUS316L Stainless steel fitting**

**VCK K 0604 -02F**

**Shape**

H	Male connector
K	40° swivel elbow
L	90° swivel elbow

**Applicable tubing (O.D. x I.D.)**

0604	6 x 4
0806	8 x 6
1075	10 x 7.5
1008	10 x 8
1209	12 x 9

- Port size**
- |     |      |
|-----|------|
| 02F | G1/4 |
|-----|------|
- \* G1/4 has special shape of bottom seal. Please refer page 652 for details.

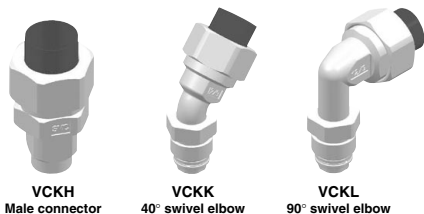

Refer to page 658 for replacement parts.

**Option**

**Blanking Plug Assembly**

Type	Model	Description	Qty.
For 2 port valve	VVCC12-10A-1	Blanking plug (with O-ring)	1
		Hexagon socket head plug (R1/4)	1
For 3 port valve	VVCC13-10A-1	Blanking plug (with O-ring)	1
		Hexagon socket head plug (R1/4)	2



- VNA
- VNB
- SGC
- SGH
- VNC
- VNH
- VND
- VCC
- TQ



# VCC Series

## Specifications

Model	VCC12	VCC13	VCC12D
Passage number	2 port	3 port <sup>Note 3)</sup>	2 port (Diaphragm type)
Construction (Fluid contact material)	Poppet seal (PEEK resin + Stainless steel) + Special fluororesin sliding part		Poppet seal (PEEK resin + Stainless steel) + Special fluororesin diaphragm
Fluid	Water/Chemical base paint, Ink, Cleaning solvent (Water, Butyl acetate), Air		
Operating pressure range (MPa)	0 to 1.0 (Instantaneous pulsation pressure: 1.2)		0 to 0.7 (Instantaneous pulsation pressure: 0.9)
Withstand pressure (MPa)	2		1.5
Pilot pressure (MPa)	0.4 to 0.7		
Orifice diameter (mm)	ø3.8		
Flow rate characteristics Kv(Cv)	IN⇔OUT: 0.28(0.33)	IN⇒OUT: 0.28(0.33) IN⇒RETURN: 0.25(0.3)	IN⇔OUT: 0.28(0.33)
Fluid temperature (°C)	5 to 50		
Ambient temperature (°C)	5 to 50		
Lubrication	Not possible (Initial lubricant: White vaseline is used.)		
Mounting orientation	Unrestricted		
Valve leakage (cm <sup>3</sup> /min)	1 or less (3 port valve IN → RETURN: 20 or less) <sup>Note 1)</sup>		1 or less <sup>Note 2)</sup>

Note 1) Supply pressure: Valve leakage at 1.2 MPa (for air)

Note 2) Supply pressure: Valve leakage at 0.9 MPa (for air)

Note 3) Pressure cannot be applied from a 3 port valve RETURN port.

## SUS316L Stainless Steel Fitting Specifications

Applicable tubing	Nylon/Fluoro tubing
Fluid	Water/Chemical base paint, Ink, Cleaning solvent (Water, Butyl acetate), Air
Max. operating pressure (at 20°C) (MPa)	1.0
Ambient and fluid temperature (°C)	0 to 60

## Weight

Valve	VCC12 (2 port)	37 g	
	VCC13 (3 port)	48 g	
Blanking plug assembly	For 2 port	29 g	
	For 3 port	45 g	
Manifold block * Valves are not attached.	For 2 port (2 stations, one-piece type)	150 g	
	For 3 port (2 stations, one-piece type)	254 g	
	For gate valve	300 g	
End plate	For 2 port	409 g	
	For 3 port	495 g	
	For 2/3 port mixed mounting	452 g	
Fittings	VCKH	ø6	24 g
		ø8	25 g
		ø10	33 g
		ø12	36 g
		ø12	37 g
	VCKK	ø6	25 g
		ø8	26 g
		ø10	32 g
		ø12	37 g
	VCKL	ø6	29 g
		ø8	30 g
		ø10	37 g
ø12		41 g	



**Dimensions**

Mounting hole dimensions (When valve is built in to the device.)

VCC12(D)-00

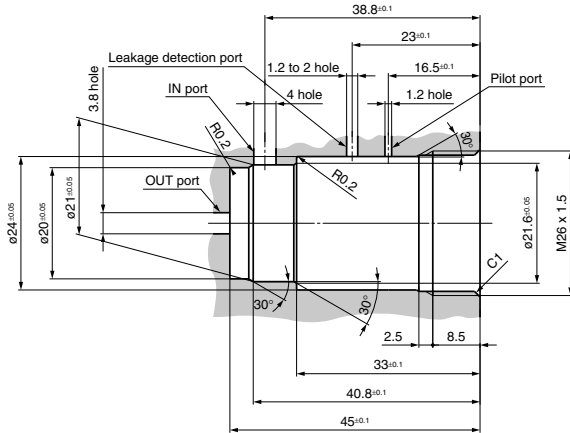

\* Recommended surface roughness of inner surface where the valve is inserted is Rz6.3.

VCC13-00

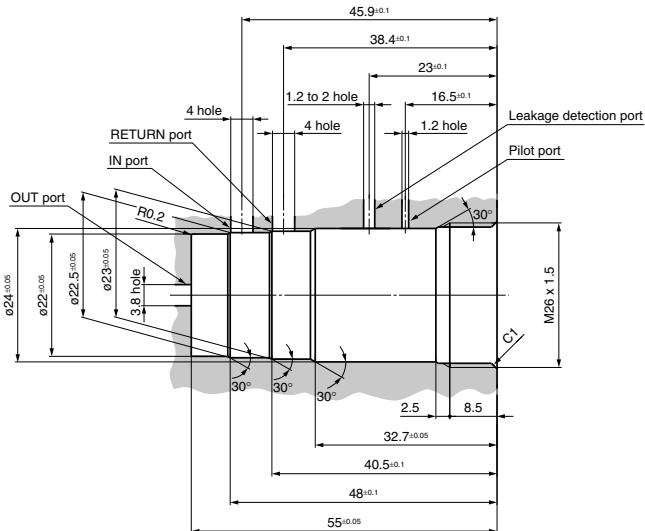

\* Recommended surface roughness of inner surface where the valve is inserted is Rz6.3.

VNA
VNB
SGC
SGH
VNC
VNH
VND
<b>VCC</b>
TQ

# VCC Series

## Dimensions

### Single valve unit

#### VCC12(D)-02(F)

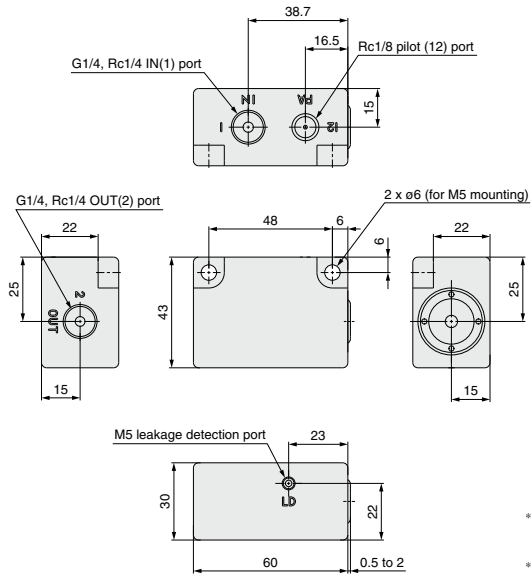

\* Part number for sub-base  
VCC12-S-02 [Rc1/4]  
02F [G1/4]

\* Sub-base material is aluminum  
+ hard anodized containing PTFE.

#### VCC13-02(F)

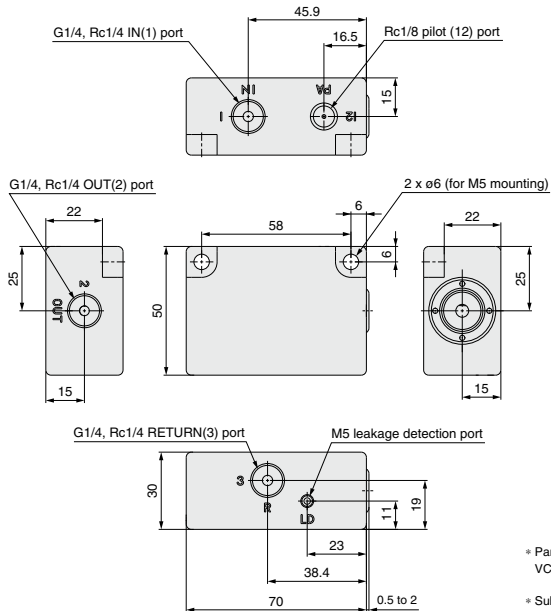

\* Part number for sub-base  
VCC13-S-02 [Rc1/4]  
02F [G1/4]

\* Sub-base material is aluminum  
+ hard anodized containing PTFE.

## Dimensions

### Manifold

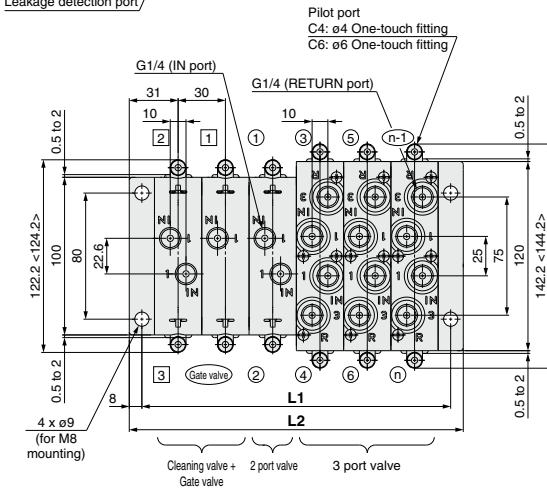
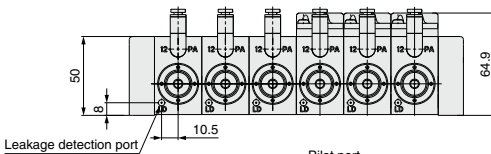
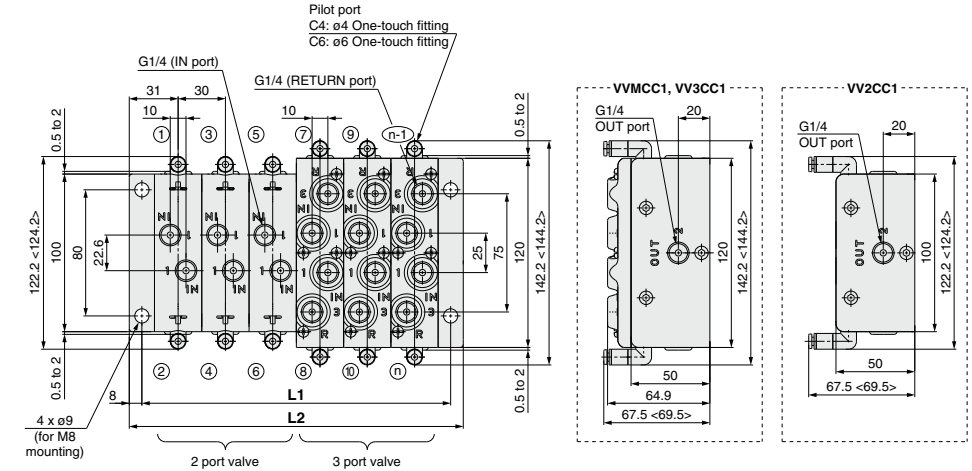

\* Aluminum + hard anodized containing PTFE and POM are used for a part of the manifold material. Refer to page 660 for details.

< > : Pilot port is C6.

$$L1 = n / 2 \times 30 + 16 \quad L2 = n / 2 \times 30 + 32$$

\* n = Number of valves (cleaning valve + gate valve + other valves)

n: Stations (mm)

n	2	4	6	8	10	12	14	16	18	20	22	24	26	28	30	32	34	36	38	40
L1	46	76	106	136	166	196	226	256	286	316	346	376	406	436	466	496	526	556	586	616
L2	62	92	122	152	182	212	242	272	302	332	362	392	422	452	482	512	542	572	602	632

# VCC Series

## Dimensions

### SUS316L Stainless steel fittings

#### Mounting female thread recommended dimensions

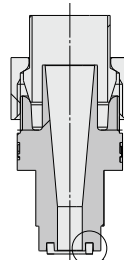
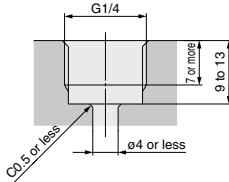

Bottom seal  
Seal material: Nylon

#### VCKH Male connector

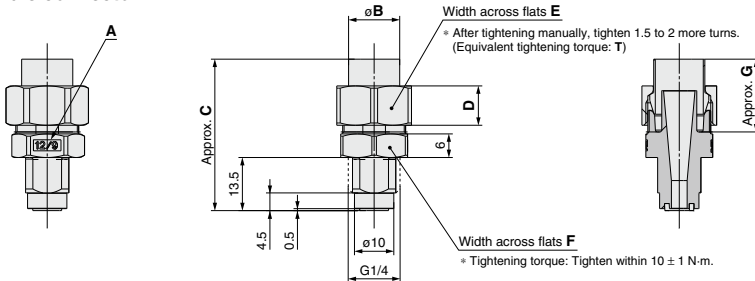

Part no.	Indication of A	øB	C	D	E	F	G	T
VCKH1209-02F	12/9	13	38.5	10	19	17	18.5	9 to 12 N·m
VCKH1008-02F	10/8	11	38	9	17	17	18.5	6 to 9 N·m
VCKH1075-02F	10-75	11	38	9	17	17	18.5	6 to 9 N·m
VCKH0806-02F	8/6	9	36.5	8	14	14	16	4 to 9 N·m
VCKH0604-02F	6/4	7	36.5	8	12	14	15	3 to 8 N·m

(mm)

#### VCKK 40° swivel elbow

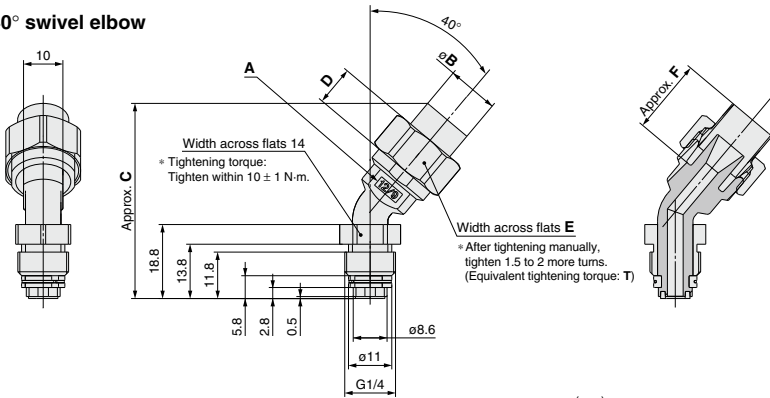

Part no.	Indication of A	øB	C	D	E	F	T
VCKK1209-02F	12/9	13	49.5	10	19	18.5	9 to 12 N·m
VCKK1008-02F	10/8	11	48.5	9	17	18.5	6 to 9 N·m
VCKK1075-02F	10-75	11	48.5	9	17	18.5	6 to 9 N·m
VCKK0806-02F	8/6	9	46	8	14	16	4 to 9 N·m
VCKK0604-02F	6/4	7	45.5	8	12	15	3 to 8 N·m

(mm)

**Dimensions**

**VCKL 90° swivel elbow**

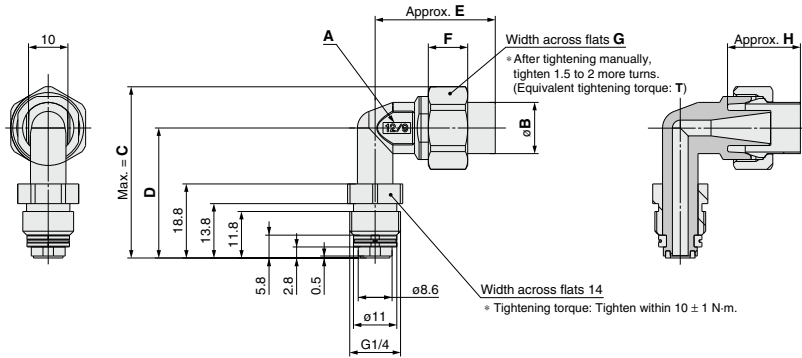

Part no.	Indication of A	øB	C	D	E	F	G	H	T
VCKL1209-02F	12/9	13	43.5	33	30.5	10	19	18.5	9 to 12 N·m
VCKL1008-02F	10/8	11	42.5	33	30	9	17	18.5	6 to 9 N·m
VCKL1075-02F	10·75	11	42.5	33	30	9	17	18.5	6 to 9 N·m
VCKL0806-02F	8/6	9	40	32	27.5	8	14	16	4 to 9 N·m
VCKL0604-02F	6/4	7	38.5	32	27.5	8	12	16	3 to 8 N·m

(mm)

VNA

VNB

SGC

SGH

VNC

VNH

VND

**VCC**

TQ

# VCC Series Special Tools

## Tool for Attaching/Detaching Valve

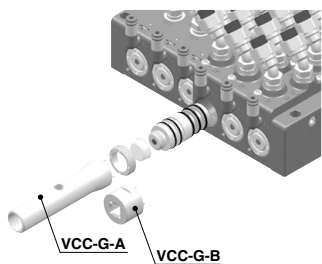

**VCC-G-A**

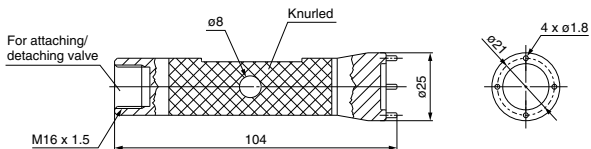

**VCC-G-B (for socket wrench)**

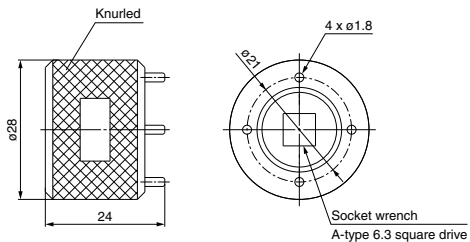

## Tool for Disassembling/Cleaning Valve Element

**VCC12(D) 2 port valve**

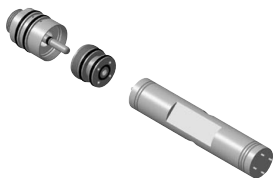

**VCC-G-C**

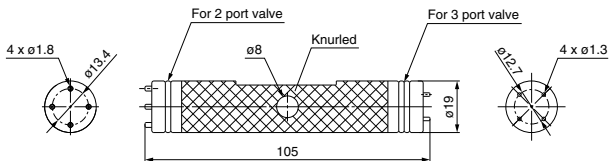

**VCC13 3 port valve**

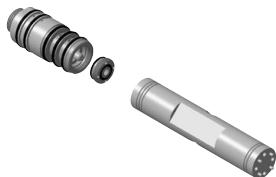

**Union Nut Socket**

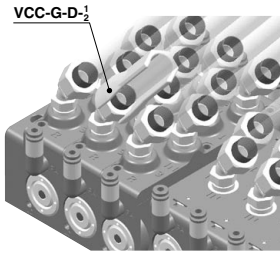

**VCC-G-D-1** (Applicable fitting VCK  $\square \begin{matrix} 1209 \\ 1008 \\ 1075 \end{matrix}$ )

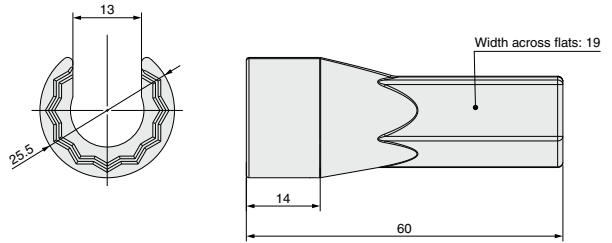

**VCC-G-D-2** (Applicable fitting VCK  $\square \begin{matrix} 0806 \\ 0604 \end{matrix}$ )

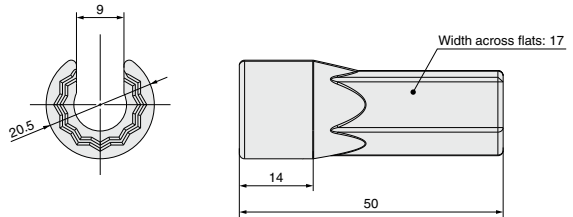

For extending the socket

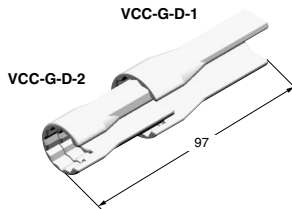
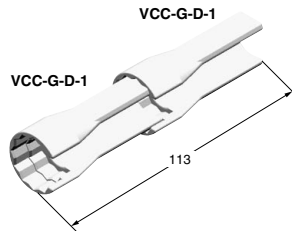

VNA
VNB
SGC
SGH
VNC
VNH
VND
<b>VCC</b>
TQ



# Disassembly/Assembly/ Maintenance Procedure

## Cleaning Valve Element

Special tool part no.: VCC-G-C

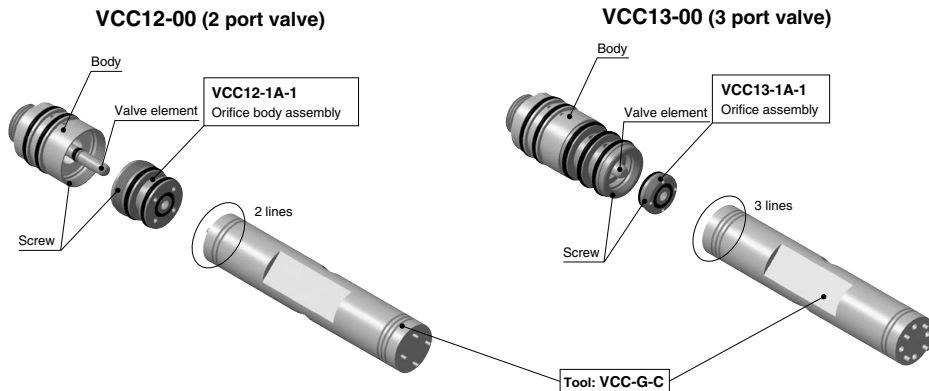

### Procedure

- ① Loosen the orifice body with a tool and remove it.
- ② Clean the valve.
- ③ Assemble a new orifice body.

VCC12(D)-00 (2 port valve)

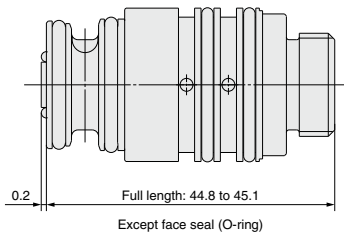

VCC13-00 (3 port valve)

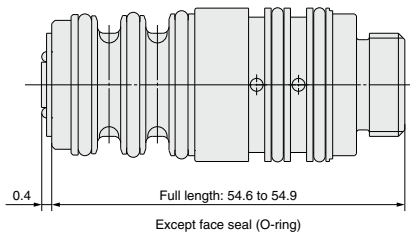

Tighten the screw until it hits the body by pressing the orifice body with approx. 100 to 200 N of force.  
(\* Additional tightening is not necessary.)

Control dimension with full length. (2 port valve: 44.8 to 45.1 mm, 3 port valve: 54.6 to 54.9 mm)

Reference tightening torque is approx. 1 to 2 N·m for VCC12(D)-00 (2 port valve), and 0.5 to 1 N·m for VCC13-00 (3 port valve).

There is a possibility of damaging threads if tightening exceeds the tightening torque range.

## How to Remove the Valve

Special tool part no.: VCC-G-A, VCC-G-B (Refer to page 654.)

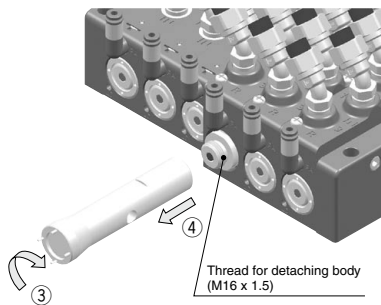
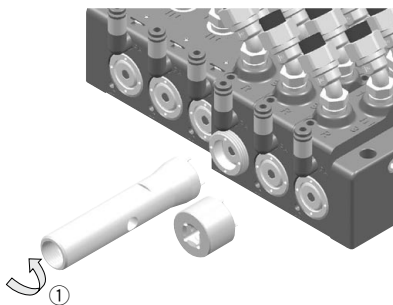

### Procedure

- ① Loosen the mounting nut with a tool to remove.
- ② Remove the indicator lamp cover.
- ③ Turn 45 to 90° (idle turn) clockwise with a tool (to avoid O-ring adhesion).
- ④ Pull out the valve straight.
- ⑤ Wipe off residual paint on inner surface of the base with a cleaning material.
- ⑥ Replace the O-ring mounted to the valve. (O-ring part number: See page 658.)

## How to Attach the Valve

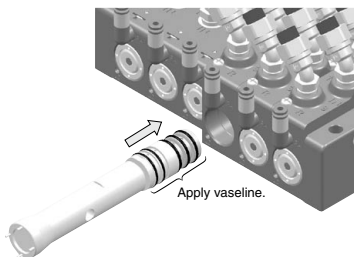

Apply vaseline (commercially available) on the O-ring surface, and insert straight. (Note the direction shown on the label.)

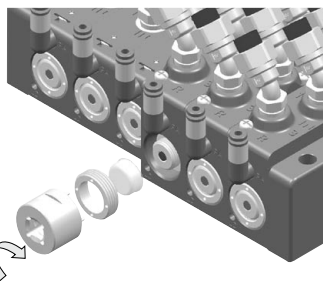

After mounting the indicator lamp cover, tighten the mounting nut to a tightening torque of 2.5 to 3.5 N·m of tightening torque.

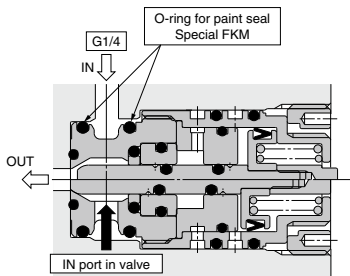

2 port valve

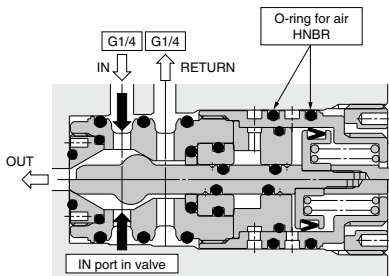

3 port valve

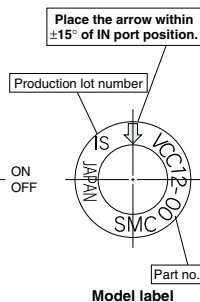

Model label

Attach and remove the valve straight. If the paint applied to the O-ring for paint adheres to the pneumatic passage, clean it. When inserting, apply vaseline to the O-ring and the inner surface of the base and insert slowly so that the O-ring is not twisted or cut. The arrow shown on the model label of the valve is set for the optimum direction for cleaning. Mount the valve so that the arrow comes to IN port position.

VNA
VNB
SGC
SGH
VNC
VNH
VND
VCC
TQ

# VCC Series Replacement Parts

## VV□CC1□: Manifold

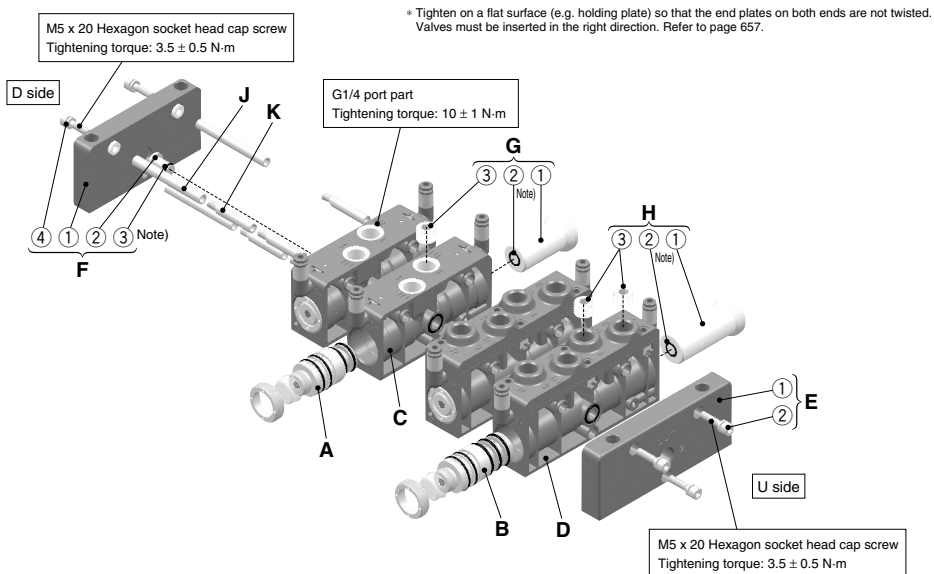

## Block Assembly

### C: 2 port valve manifold block assembly Manifold block assembly for gate valve

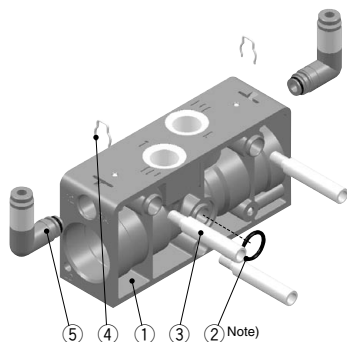

\* The figure shows the 2 port valve manifold block assembly.

### D: 3 port valve manifold block assembly

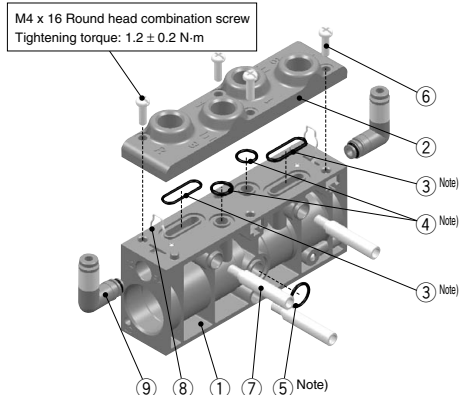

### Component Parts

Model	Part no.	Description	Symbol	Component	Material	Qty.	Order qty.
VV2CC1 VV3CC1 VVMCC1 (common)	VVCC12-OR-1	O-ring between manifold blocks	C-② D-⑤	O-ring	Special FKM	1	1 set unit
	VVCC12-50A-L1C4	ø4 One-touch fitting	C-⑤	One-touch fitting	—	1	
	VVCC12-50A-L1C6	ø6 One-touch fitting	D-⑨	O-ring	HNBR	1	1 set unit
	VVCC12-OR-3	O-ring	F-③	O-ring	Special FKM	1	1 set unit
VV3CC1 VVMCC1	VVCC13-OR-1	O-ring assembly between port blocks	D-③ D-④	O-ring	Special FKM	2	1 set unit
				O-ring	Special FKM	2	

Note) If the manifold is disassembled or rearranged, replace the O-rings with new O-rings. (Specific Product Precautions 4/Maintenance 5 on page 665)

### 2/3 Port Valve

#### A: 2 port valve Standard VCC12-00

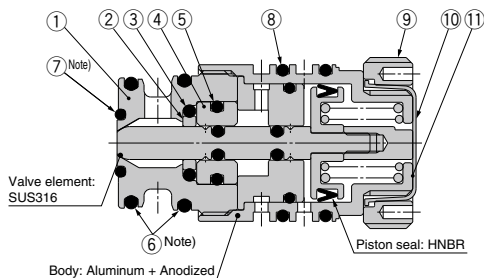

#### Diaphragm / 2 liquid paint type VCC12D-00

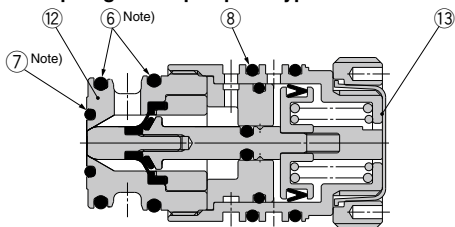

#### B: 3 port valve VCC13-00

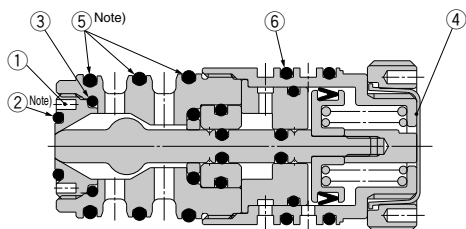

#### Component Parts

Model	Part no.	Description	Symbol	Component	Material	Qty.	Order qty.	
VCC12(D)-00 (dedicated)	VCC12-1A-1 (for VCC12-00)		A-1	Orifice body	PEEK resin	1	1 set unit	
			A-2	PTFE seal	Special PTFE	1		
	A-3	O-ring	Special FKM	1				
	A-4	Sleeve	POM	1				
	A-5	O-ring	Special FKM	1				
	A-6	O-ring	Special FKM	2				
	A-7	O-ring	Special FKM	1				
	A-11	Name plate	—	1				
	VCC12D-1A-1 (for VCC12D-00)		A-6	O-ring	Special FKM	2		1 set unit
			A-7	O-ring	Special FKM	1		
VCC12-OR-1		A-12	Orifice body	PEEK resin	1	1 set unit		
		A-13	Name plate	—	1			
		A-6	O-ring	Special FKM	2			
		A-7	O-ring	Special FKM	1			
VCC12-OR-4		A-8	O-ring	HNBR	2	1 set unit		
		A-6	O-ring	Special FKM	2			
VCC13-00 (dedicated)	VCC13-1A-1 	B-1	Orifice	PEEK resin	1	1 set unit		
		B-2	O-ring	Special FKM	1			
		B-3	O-ring	Special FKM	1			
	VCC13-OR-1		B-4	Name plate	—	1	1 set unit	
			B-2	O-ring	Special FKM	1		
	VCC13-OR-2		B-5	O-ring	Special FKM	3	1 set unit	
B-6			O-ring	HNBR	2			
VCC12(D)-00 VCC13-00 (common)	VCC12-2A-1 	Mounting nut assembly	A-9	Mounting nut	Aluminum	1	1 set unit	
			A-10	Switching display cover	A-PET	1		
	VCC12-OR-5		B-2	O-ring	Special FKM	1	1 set unit	
			G-2	O-ring	Special FKM	1		
			H-2	O-ring	Special FKM	1		
VCC10-30A-1	Switching display cover	A-10	Switching display cover	A-PET	10	1 set unit		

Note) If the manifold is disassembled or rearranged, replace the O-rings with new O-rings. (Specific Product Precautions 4/Maintenance 5 on page 665)

VNA  
VNB  
SGC  
SGH  
VNC  
VNH  
VND  
VCC  
TQ

## Parts Description

Model	Symbol	Part no.	Description	Symbol	Description	Material	Surface treatment	Note
For 2 port valve	A	VCC12(D)-00	<b>2 port valve</b>	—	—	—	—	—
	C	VVCC12-1A-02F <sup>C4</sup> <sub>C6</sub> * Pilot port C4: e4 piping C6: e6 piping	<b>Manifold block assembly for 2 port valve</b>	①	<b>Manifold block</b>	PPS resin	—	For VVCC12-1A-02F <sup>C4</sup> <sub>C6</sub>
				②	<b>O-ring</b>	Special FKM	—	—
				③	<b>Tie-rod for adding stations</b>	Stainless steel	—	For adding stations
				④	<b>Clip</b>	Stainless steel	—	—
				⑤	<b>One-touch fitting</b>	—	—	Refer to "Replacement Parts."
	E	VVCC12-2A-02F	<b>U-side end plate assembly for 2 port valve</b>	①	<b>U-side end plate</b>	Aluminum	Hard anodized containing PTFE	When neighboring valve is a 2 port valve.
				②	<b>Hexagon socket head cap screw with M5 x 20 SW</b>	Stainless steel	—	
	F	VVCC12-3A-1	<b>D-side end plate assembly for 2 port valve</b>	①	<b>D-side end plate</b>	Aluminum	Hard anodized containing PTFE	When neighboring valve is a 2 port valve.
				②	<b>Plug</b>	POM	—	
③				<b>O-ring</b>	Special FKM	—		
④				<b>Hexagon socket head cap screw with M5 x 20 SW</b>	Stainless steel	—		
G	VVCC12-10A-1	<b>Blanking plug assembly for 2 port valve</b>	①	<b>Blanking plug</b>	POM	—	—	
			②	<b>O-ring</b>	Special FKM	—	—	
			③	<b>R1/4 Hexagon socket head plug</b>	Stainless steel	—	—	
For 3 port valve	B	VCC13-00	<b>3 port valve</b>	—	—	—	—	—
	D	VVCC13-1A-02F <sup>C4</sup> <sub>C6</sub> * Pilot port C4: e4 piping C6: e6 piping	<b>Manifold block assembly for 3 port valve</b>	①	<b>Manifold block</b>	PPS resin	—	—
				②	<b>Port block</b>	Aluminum	Hard anodized containing PTFE	—
				③	<b>O-ring</b>	Special FKM	—	—
				④	<b>O-ring</b>	Special FKM	—	—
				⑤	<b>O-ring</b>	Special FKM	—	—
				⑥	<b>Round head combination screw with M4 x 16 SW</b>	Stainless steel	—	—
				⑦	<b>Tie-rod for adding stations</b>	Stainless steel	—	For adding stations
				⑧	<b>Clip</b>	Stainless steel	—	—
				⑨	<b>One-touch fitting</b>	—	—	Refer to "Replacement Parts."
E	VVCC13-2A-02F	<b>U-side end plate assembly for 3 port valve</b>	①	<b>U-side end plate</b>	Aluminum	Hard anodized containing PTFE	When neighboring valve is a 3 port valve.	
			②	<b>Hexagon socket head cap screw with M5 x 20 SW</b>	Stainless steel	—		
F	VVCC13-3A-1	<b>D-side end plate assembly for 3 port valve</b>	①	<b>D-side end plate</b>	Aluminum	Hard anodized containing PTFE	When neighboring valve is a 3 port valve.	
			②	<b>Plug</b>	POM	—		
			③	<b>O-ring</b>	Special FKM	—		
			④	<b>Hexagon socket head cap screw with M5 x 20 SW</b>	Stainless steel	—		
H	VVCC13-10A-1	<b>Blanking plug assembly for 3 port valve</b>	①	<b>Blanking plug</b>	POM	—	—	
			②	<b>O-ring</b>	Special FKM	—	—	
			③	<b>R1/4 Hexagon socket head plug</b>	Stainless steel	—	—	
Common	J	VVCC12-20A-□	<b>Tie-rod</b>	—	—	Stainless steel	—	□ = Three manifold blocks make up one set.
	K	VVCC12-21A	<b>Tie-rod for adding stations</b>	—	—	Stainless steel	—	3 pcs. make up one set. <sup>(Note)</sup>

Note) When the manifold is shipped out, tie-rods for two extra stations are used. You can add or reduce 2 stations of manifold block (4 valves in total).

Example) For manifold block 4 stations (8 valves)

Tie-rod for 2 stations (VVCC12-20A-2)	Tie-rod for adding stations (VVCC12-21A)	Tie-rod for adding stations (VVCC12-21A)
--	---	---

Example) For manifold block 5 stations (10 valves)

Tie-rod for 3 stations (VVCC12-20A-3)	Tie-rod for adding stations (VVCC12-21A)	Tie-rod for adding stations (VVCC12-21A)
--	---	---

**SUS316L Stainless Steel Fitting**

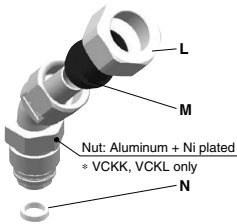

**Component Parts**

Model	Symbol	Part no.	Description	Conforming item	Material	Qty.	Order qty.
K VCKL□□□□-02F H	L	KFN-06-X2	Union nut	K VCKL0604-02F H	C3604BD + Ni plated	1	1 set unit
		KFN-08-X2		K VCKL0806-02F H			
		KFN-10-X2		K VCKL1075-02F H			
				K VCKL1008-02F H			
		KFN-12-X2		K VCKL1209-02F H			
	M	KFS-06	Sleeve	K VCKL0604-02F H	Nylon	1	1 set unit
		KFS-08		K VCKL0806-02F H			
		KFS-10		K VCKL1075-02F H			
				K VCKL1008-02F H			
		KFS-12		K VCKL1209-02F H			
	N	VCKK-4-1	Gasket		Nylon	1	10 set unit

- VNA
- VNB
- SGC
- SGH
- VNC
- VNH
- VND
- VCC**
- TQ



# VCC Series

## Specific Product Precautions 1

Be sure to read this before handling the products.

Refer to back page 50 for Safety Instructions and pages 17 to 19 for 2 Port Solenoid Valve for Fluid Control Precautions.

### Design

#### ⚠ Warning

- 1. Cannot be used as an emergency shutoff valve, etc.**  
The valves presented in this catalog are not designed for safety applications such as an emergency shutoff valve. If the valves are used in this type of system, other reliable safety assurance measures should also be adopted.
- 2. Maintenance space**  
The installation should allow sufficient space for maintenance activities.
- 3. When an impact, such as water hammer, etc., caused by the rapid pressure fluctuation is applied, the solenoid valve may be damaged. Use care when handling.**

### Selection

#### ⚠ Warning

- 1. Confirm the specifications.**  
Give careful consideration to the operating conditions such as the application, fluid and environment, and use within the operating ranges specified in this catalog. Also, be sure to carry out an evaluation using an actual product to ensure that problems do not occur under the working conditions.
- 2. Fluid**
  - 1) Applicable fluid on the list may not be used depending on the operating condition.**  
Give adequate confirmation, and then determine a model, just because the compatibility list shows the general case.
- 3. Air quality**
  - 1) Use clean air.**  
Do not use compressed air which includes chemicals, synthetic oils containing organic solvents, salt or corrosive gases, etc., as it can cause damage or malfunction.
  - 2) Install air filters.**  
Install air filters close to valves at their upstream side. A filtration degree of 5 μm or less should be selected.
  - 3) Install an air dryer or after-cooler, etc.**  
Compressed air that includes excessive drainage may cause malfunction of valves and other pneumatic equipment. To prevent this, install an air dryer or after-cooler, etc.
  - 4) If excessive carbon powder is generated, eliminate it by installing mist separators at the upstream side of valves.**  
If excessive carbon powder is generated by the compressor, it may adhere to the inside of the valves and cause a malfunction.  
Refer to Best Pneumatics No.5 for further details on compressed air quality.
- 4. Ambient environment**  
Use within the operable ambient temperature range. Confirm the compatibility between the product's composition materials and the ambient atmosphere. Be sure that the fluid used does not touch the external surface of the product.
- 5. Countermeasures against static electricity**  
Take measures to prevent static electricity since some fluids can cause static electricity.

### Piping

#### ⚠ Caution

- 1. Preparation before piping**  
Before piping is connected, it should be thoroughly blown out with air (flushing) or washed to remove chips, cutting oil and other debris from inside the pipe.  
Install piping so that it does not apply pulling, pressing, bending or other forces on the valve body.
- 2. Winding of sealant tape**  
When connecting pipes, fittings, etc., be sure that chips from the pipe threads and sealing material do not enter the valve.  
Furthermore, when sealant tape is used, leave 1.5 to 2 thread ridges exposed at the end of the threads.

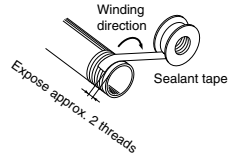

- 3. Avoid connecting ground lines to piping, as this may cause electric corrosion of the system.**
- 4. Always tighten threads with the proper tightening torque.**  
When attaching fittings to valves, tighten with the proper tightening torque shown below.

#### Tightening Torque for Piping

Connection threads	Proper tightening torque N·m
Rc 1/8	7 to 9
Rc 1/4	12 to 14
G 1/4	9 to 11

- 5. Connection of piping to products**  
When connecting piping to a product, refer to its instruction manual to avoid mistakes regarding the supply port, etc.

### Operating Environment

#### ⚠ Warning

- 1. Do not use the valves in an atmosphere having corrosive gases, chemicals, salt water, water, steam, or where there is direct contact with any of these.**
- 2. Do not use in locations subject to vibration or impact.**
- 3. Do not use in locations where radiated heat will be received from nearby heat sources.**
- 4. Employ suitable protective measures in locations where there is contact with water droplets, oil or welding spatter, etc.**





## VCC Series

# Specific Product Precautions 2

Be sure to read this before handling the products.

Refer to back page 50 for Safety Instructions and pages 17 to 19 for 2 Port Solenoid Valve for Fluid Control Precautions.

### Maintenance

#### **Caution**

##### 1. Filters and strainers

- 1) Be careful regarding clogging of filters and strainers.
- 2) Replace filter elements after one year of use, or earlier if the pressure drop reaches 0.1 MPa.
- 3) Clean strainers when the pressure drop reaches 0.1 MPa.

##### 2. Storage

In case of long term storage after use with heated water, thoroughly remove all moisture to prevent rust and deterioration of rubber materials, etc.

##### 3. Exhaust the drain from an air filter periodically.

VNA

VNB

SGC

SGH

VNC

VNH

VND

**VCC**

TQ



## VCC Series

# Specific Product Precautions 3

Be sure to read this before handling the products.

Refer to back page 50 for Safety Instructions and pages 17 to 19 for 2 Port Solenoid Valve for Fluid Control Precautions.

### Design

#### Warning

##### 1. Leakage detection port

The valve has leak detection area to completely separate the fluid area and pilot pressure area. If leakage is found, valve replacement and maintenance are necessary immediately. Fluids that solidify or being cured may block the leak detection so port and leak may not be detected.

##### 2. If applying high voltage to the fluid, it must be earthed by using the bolt to mount the base.

Do not use sealing tape when piping, as it may insulate.

### Selection

#### Caution

##### 1. Operating fluid

Eliminate all solid material larger than 150 μm in the fluid to avoid valve failure.

### Piping

#### Caution

##### 1. Piping to pilot port

Condensation may be formed in the piping to the pilot port, due to factors such as its length. The life of the valve will be shortened if condensed moisture enters the pilot port. To prevent condensation, the installation of a quick exhaust is recommended.

##### 2. Tube attachment/detachment for One-touch fittings/stainless steel fittings

###### 1) Attaching of the tubing

a Divide a tube with no external flaws at a right angle. Use tube cutter TK-1, 2, or 3 when dividing the tube. Do not use pliers, nipper pliers, scissors, etc. This may result in flattening and an inability to join, or the tube falling out and air leakage.

b The outer diameter of polyurethane tubing will expand when internal pressure is applied, and so you may not be able to reattach One-touch fittings. Check the tubing outer diameter of all tubing other than for the release bushing, and reattach the One-touch fittings without dividing the tubing if the outer diameter precision is more than ±0.15 mm. When reattaching the One-touch fittings, check whether the tubing can smoothly pass through the release bushing.

c Grasp the tubing, slowly push it straight (0 to 5°) into the One-touch fitting until it comes to a stop.

d Once pushed all the way in, gently pull the tubing back, and check that it hasn't come all the way out. If not firmly inserted all the way in, it may result in air leakage and the tube falling out.

### Piping

#### Caution

- e If the union nut is loose, tighten it by hand temporarily. Then, fix the body with the tightening tool, and tighten the union nut with an appropriate wrench, applying the torque shown below.

Fitting size	Appropriate tightening rotations	Equivalent tightening torque N·m
VCK□06	1.5 to 2.0	3 to 8
VCK□08	1.5 to 2.0	4 to 9
VCK□10	1.5 to 2.0	6 to 9
VCK□12	1.5 to 2.0	9 to 12

##### 2) Detaching of the tubing

- a Push in the release button sufficiently, pushing the collar evenly.
- b Pull the tube out while pressing so that the release button is not returned. If the release button is not pressed sufficiently, gripping will instead increase and it will become harder to pull out.
- c Before reusing the detached tube, first cut off the portion of tubing that had been gripped. Using the portion of tubing that had been gripped will lead to air leakage and the tube will become harder to detach.

##### 3. Joining a metal rod accessory

After joining a metal rod accessory (KC series, etc.) to a One-touch fitting, do not use a tube, resin plug, reducer, etc, as it may result in the tube falling out.

##### 4. When attaching a tube, resin plug, metal rod, etc., do not attach while pressing on the release bushing.

##### 5. When using another brand tubing, check whether the tubing material and outer diameter precision meet the following specifications.

- 1) Nylon tubing within ±0.1 mm
- 2) Soft nylon tubing within ±0.1 mm
- 3) Polyurethane tubing within ±0.15 mm, -0.2 mm

If tubing outer diameter tolerance is not met, do not use if tubing inner diameter differs from our brand.

This may result in inability to join, leakage, the tube falling out, and damage to the fitting.

### Lubrication

#### Caution

##### 1. Do not lubricate the valve.

The valve uses white vaseline as lubricant.



## VCC Series

# Specific Product Precautions 4

Be sure to read this before handling the products.

Refer to back page 50 for Safety Instructions and pages 17 to 19 for 2 Port Solenoid Valve for Fluid Control Precautions.

### Maintenance

#### Caution

##### 1. Removing the product

- 1) Shut off the fluid supply and release the fluid pressure in the system.
- 2) Dismount the product.

##### 2. Low frequency operation

Switch valves at least once every 30 days to prevent malfunction. Also, in order to use it under the optimum state, conduct a regular inspection once a half year.

##### 3. Stoppage of line

When the line is stopped for a long time, clean the valve so that fluid (paint, ink, etc.) does not solidify or being cured.

##### 4. Prolonged usage

Leakage may occur with fittings and tube material as they change over time. Additionally tighten union nuts. Additional tightening should be 1/6 to 1/4 turn. If leakage occurs even after additional tightening, replace the sleeve with a new one.

##### 5. Due to the characteristics of the material (Special FKM), the compression value of the O-rings of the VCC series is higher. Therefore, when disassembly or rearrangement of the product is performed, leakage may occur if the O-rings are not replaced. If disassembly or rearrangement is performed, replace the O-rings with new O-rings.

##### 6. If disassembly, rearrangement, or maintenance is performed, perform sufficient safety checks before operating the system. In addition, SMC assumes no responsibility concerning damage caused by methods other than those described in the catalog and operation manual.

### Return of Product

#### Warning

If the product to be returned is contaminated or is possibly contaminated with substances that are harmful to humans, for safety reasons, please contact SMC beforehand and then employ a specialist cleaning company to decontaminate the product. After the decontamination prescribed above has been carried out, submit a Product Return Request Sheet or the Detoxification/Decontamination Certificate to SMC and await SMC's approval and further instructions before attempting to return the item.

Please refer to the International Chemical Safety Cards (ICSC) for a list of harmful substances.

If you have any further questions, please don't hesitate to contact your SMC sales representative.

VNA

VNB

SGC

SGH

VNC

VNH

VND

VCC

TQ

# Manifold Specifications

## VCC Series

### 1. How to Order Manifold

VV **M** CC1-**06** **10** **C4** - **G04**

①                      ②           ③           ④                      ⑤

\* This "How to Order" is that of the example below.

#### ① Type (Passage number)

<b>2</b>	2 port valve
<b>3</b>	3 port valve
<b>M</b>	2/3 port valves mixed mounting

#### ② 2 port valve mountable number Note 1)

<b>00</b>	Without 2 port valve
<b>02</b>	2 pcs. (colors)
<b>04</b>	4 pcs. (colors)
⋮	⋮
<b>40</b>	40 pcs. (colors) <small>Note 2)</small>

#### ④ Pilot port fitting size

<b>C4</b>	ø4 One-touch fitting
<b>C6</b>	ø6 One-touch fitting

#### ③ 3 port valve mountable number Note 1)

<b>00</b>	Without 3 port valve
<b>02</b>	2 pcs. (colors)
<b>04</b>	4 pcs. (colors)
⋮	⋮
<b>40</b>	40 pcs. (colors) <small>Note 2)</small>

#### ⑤ Gate valve and cleaning valve mountable number Note 1)

<b>Nil</b>	Without gate valve <small>Note 3)</small>
<b>G02</b>	Cleaning valve: 1 pc. + Gate valve: 1 pc.
<b>G04</b>	Cleaning valve: 3 pcs. + Gate valve: 1 pc.
<b>G06</b>	Cleaning valve: 5 pcs. + Gate valve: 1 pc.

Note 1) Two valves can be installed per manifold block. Total valve number must be an even number.

Note 2) Maximum valve number is forty (40) valves (colors) by total of ② + ③ + ⑤.

Note 3) When "Without gate valve" is selected, use 2 port valve of ② as a cleaning valve.

### 2. How to Order Valve

VCC1**2**-00

①

#### ① Type (Passage number)

<b>2</b>	2 port valve
<b>3</b>	3 port valve
<b>2D</b>	2 port/Diaphragm type

### 3. How to Order Blanking Plug

VVCC1**2**-10A-1

①

#### ① Type (Passage number)

<b>2</b>	For 2 port valve
<b>3</b>	For 3 port valve

Used when number of valves used on the manifold base is an odd number.

### 4. How to Order SUS316L Stainless Steel Fitting

VCK**K** **1075**-02F

①                      ②

#### ① Type (Shape)

<b>K</b>	40° swivel elbow
<b>L</b>	90° swivel elbow
<b>H</b>	Male connector

#### ② Piping port

<b>1209</b>	Piping port for ø12 x ø9
<b>1008</b>	Piping port for ø10 x ø8
<b>1075</b>	Piping port for ø10 x ø7.5
<b>0806</b>	Piping port for ø8 x ø6
<b>0604</b>	Piping port for ø6 x ø4

